

Revisions			
Rev	Description	Date	Approved:
A	Initial Release	2026.4.9	A. M

ELECTRICAL PERFORMANCE

- 1. Frequency Range: 39.2-59.6 GHz
- 2. VSWR: 1.05 max.
- 3. WG Type: WR19
- 4. Power: 0.5W

MATERIAL

- 1. Body: Brass, Gold Plated

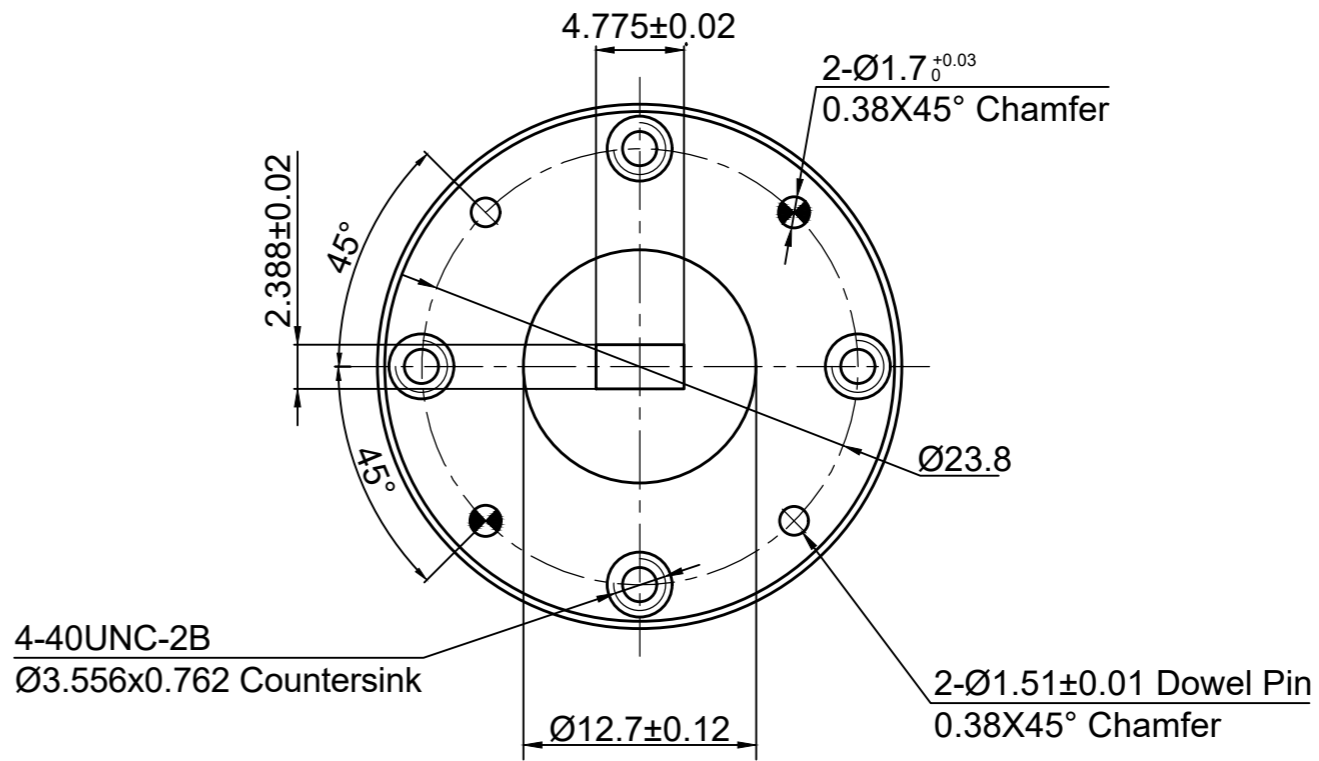
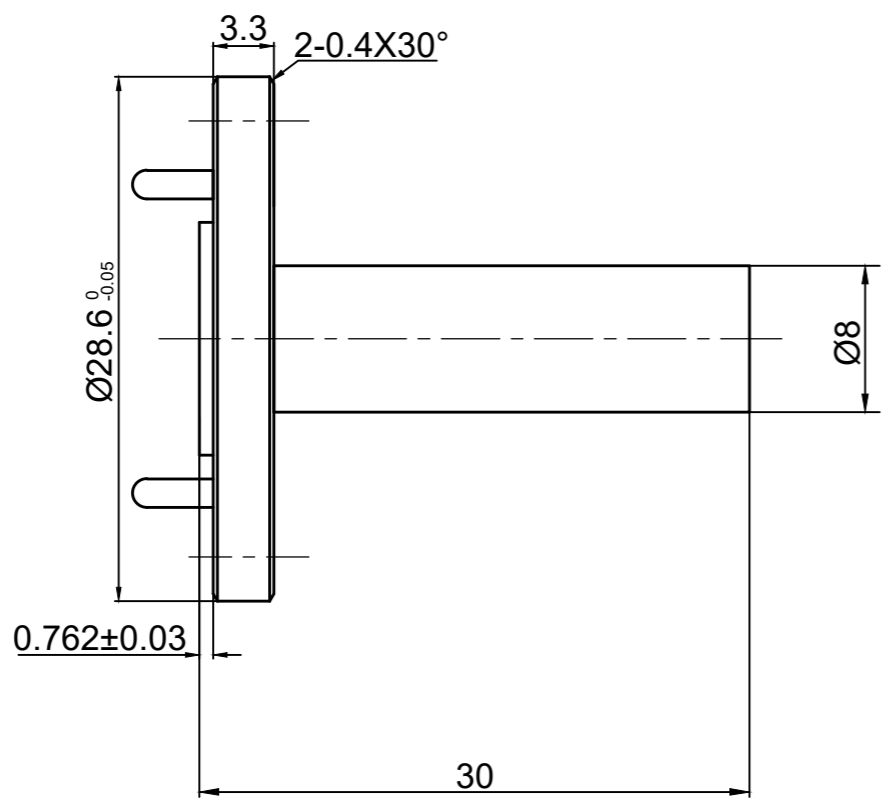

NOTES:

- 1. ALL SPECIFICATIONS ARE SUBJECT TO CHANGE WITHOUT NOTICE AT ANY TIME
- 2. CUSTOMER OUTLINE DRAWING FOR REFERENCE ONLY

Drawn:	W. Y 2026.4.9
Checked:	T. L 2026.4.9
Approved:	A. M 2026.4.9
Unless Otherwise Specified Dimensions are in Millimeters, Dimensions in [] are in Inches for Customer Reference Only. Unless Otherwise Specified Tolerance are: .XX ±0.13 [.005"] .X ±0.20 [.008"] X ±0.50 [.019"] .X° ±1° X° ±2°	

Title:	WR19 Load Freq 39.2-59.6 GHz
Part No:	DWL19T



View:	
Size:	A3
Scale:	2:1
Sheet:	1/1
Rev:	A